



IWAKI
MAGNETIC
DRIVE
PUMPS

MX



Patent

JAPAN / U.S.A. / EU / CHINA / TAIWAN

Solutions for chemical handling applications

Even better dry-running resistance and efficiency than previous models. Iwaki MX magnetic drive pumps - reliable & energy efficient.

The MX Series represents the latest state of the art design in plastic magnetic drive pumps to meet the most severe of operating conditions.

When fitted with a carbon bearing the MX will allow for brief periods of dry running. The new "self radiating structure" (PAT.) in addition to the existing proven non contact principle and front and rear supported spindle greatly improves the pumps ability to withstand some cavitation and running against closed discharge valve. Our innovative design has achieved higher efficiency. MX series pumps are highly recommended for use in various production processes such as filtering, spraying, washing and etching in surface treatment processes.

- An improved mechanical strength design allows operation under abnormal conditions and results in reduction of running cost and maintenance cost.
- The split-volute casing significantly improves efficiency over previous versions.
- Simple yet robust construction allows easy maintenance.

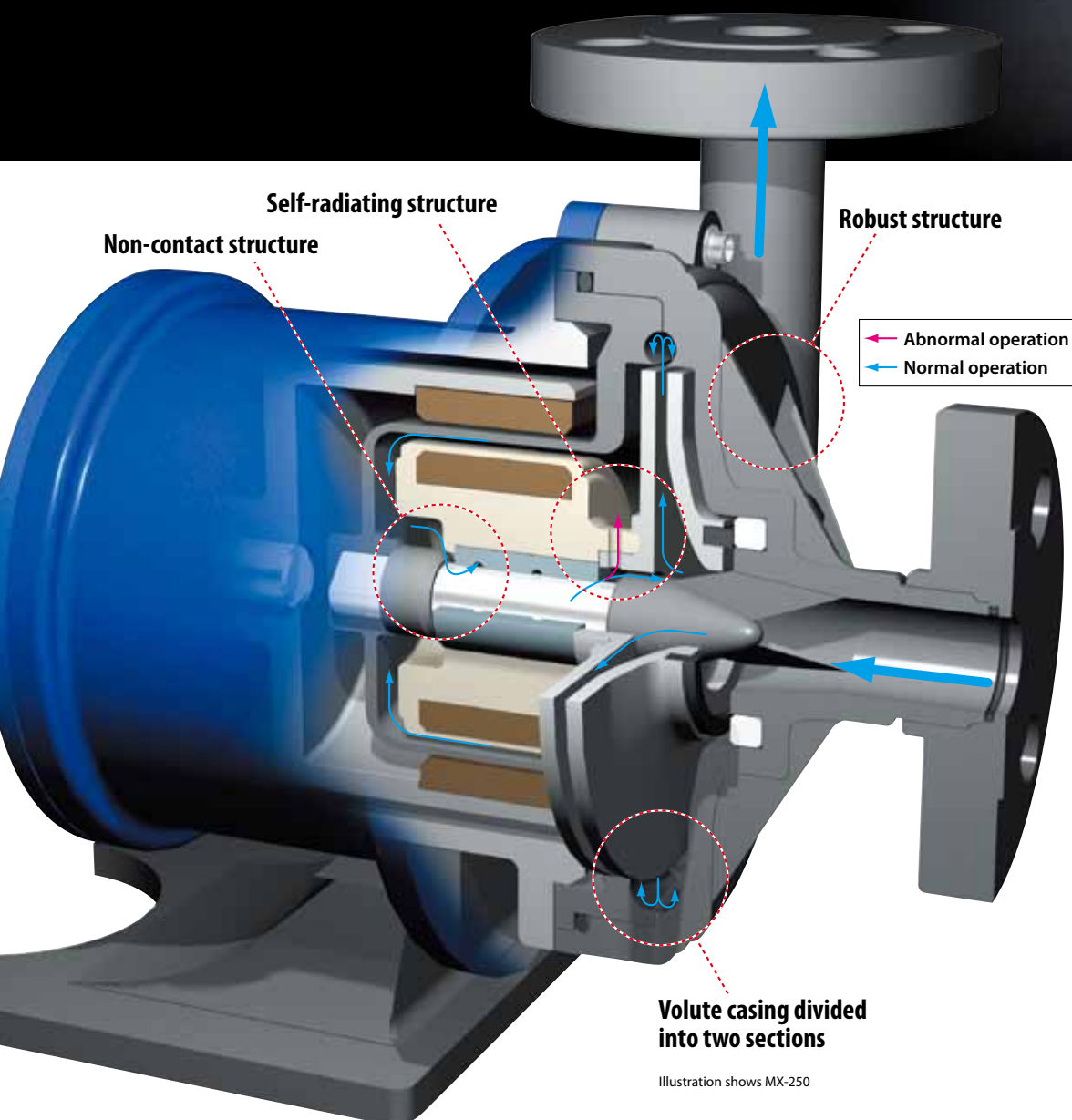



Self-radiating structure (PAT.)

Through heat-dispersion holes provided in the fixed portions of the impeller and the magnet capsule, the liquid around the spindle and the bearing is forced to circulate so that heat generated by sliding can be reduced effectively. Thus, thermal deformation and melt are prevented.

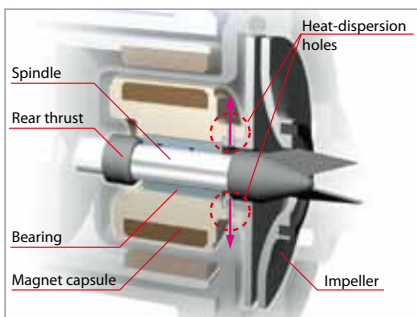

Non-contact structure

By installing the driving magnet and the driven magnet in an inventive way, the movement of the magnet capsule is controlled by magnetic force to prevent the rear thrust and the rear portion of the bearing coming into contact with each other continuously even during dry run-

ning. This structure reduces heat generation and secures lubricant routes.

(Except MX-70, 100)

Volute casing divided into two sections (PAT.)

The MX series is the first resin magnet pump which uses the pump casing divided into the front casing and the rear casing to form a vortex chamber as an ideal form. Therefore, the internal leak phenomenon, which means that the liquid getting out of the impeller returns to the pump casing and is suppressed to a minimum and the liquid is efficiently guided to the discharge port to enhance overall efficiency. (Except MX-70, 400, 505)



Front casing



Rear casing



Front casing of type 100 and 402/403

Robust structure

All stress bearing portions, such as the front and rear casings, are reinforced by means of ribs to improve the pressure resistance and the mechanical strength of the pump.

The bearing is not only fixed by conventional press fit but is also sandwiched between the abutting portion in the depth of the magnet capsule and the rear end of the impeller to improve its reliability under high temperature.

(Except MX-70, 100)

MX-402(H), 403(H) and 505 models: an unplugging preventive lock pin is adopted for ensuring more steady securing.



MX-505

MX-403

Wet end materials

■ MX-70,100

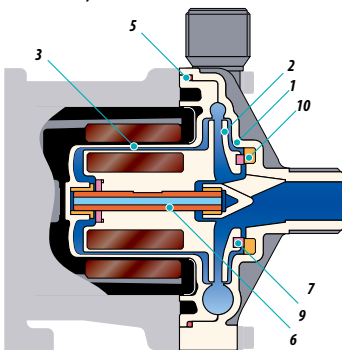

Model	MX-70	MX-100
Mark	V(E)	
1 Front casing	GFRPP	
2 Impeller	CFRPP	
3 Rear casing	GFRPP	
5 O ring	Note	FKM(EPDM)
6 Spindle	Alumina ceramic	
7 Bearing	CFRPPS	PTFE(with filler)
9 Mouth ring	-	PTFE(with filler)
10 Thrust/Liner ring	Alumina ceramic	

Note: An O-ring made of AFLAS® is also available

■ MX-250 to 401

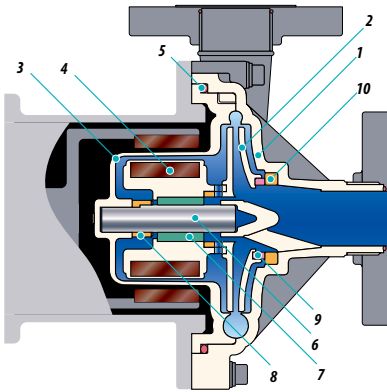

■ MX-402 to 403H

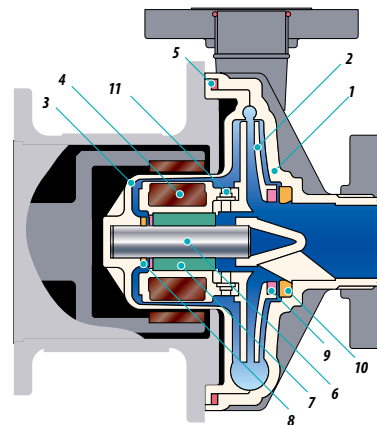

■ MX-505

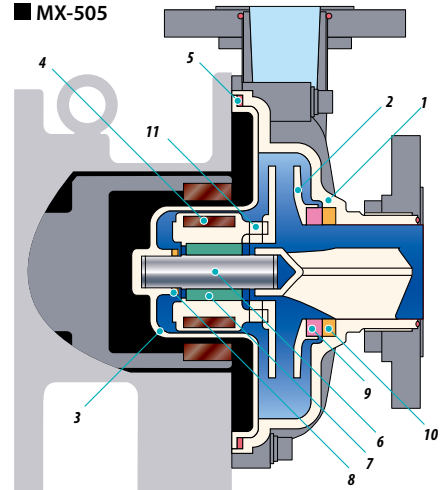

Model	MX-250 to 505		MX-250 to 401
	CV(CE)	RV(RE)	AV(AE)
1 Front casing	GFRPP		
2 Impeller	GFRPP		
3 Rear casing	GFRPP		
4 Magnet capsule	PP		
5 O ring	Note	FKM(EPDM)	
6 Spindle	High purity alumina ceramic		
7 Bearing	Carbon	PTFE(with filler)	Alumina ceramic
8 Rear thrust	CFRPPS (MX-402 to 505: CFRPEEK)		
9 Mouth ring	PTFE(with filler)		
10 Thrust/Liner ring	Alumina ceramic		
11 Lock pin	GFRPPS(Only available type 402 to 505)		-

Note: An O-ring made of AFLAS® is also available



Pump identification

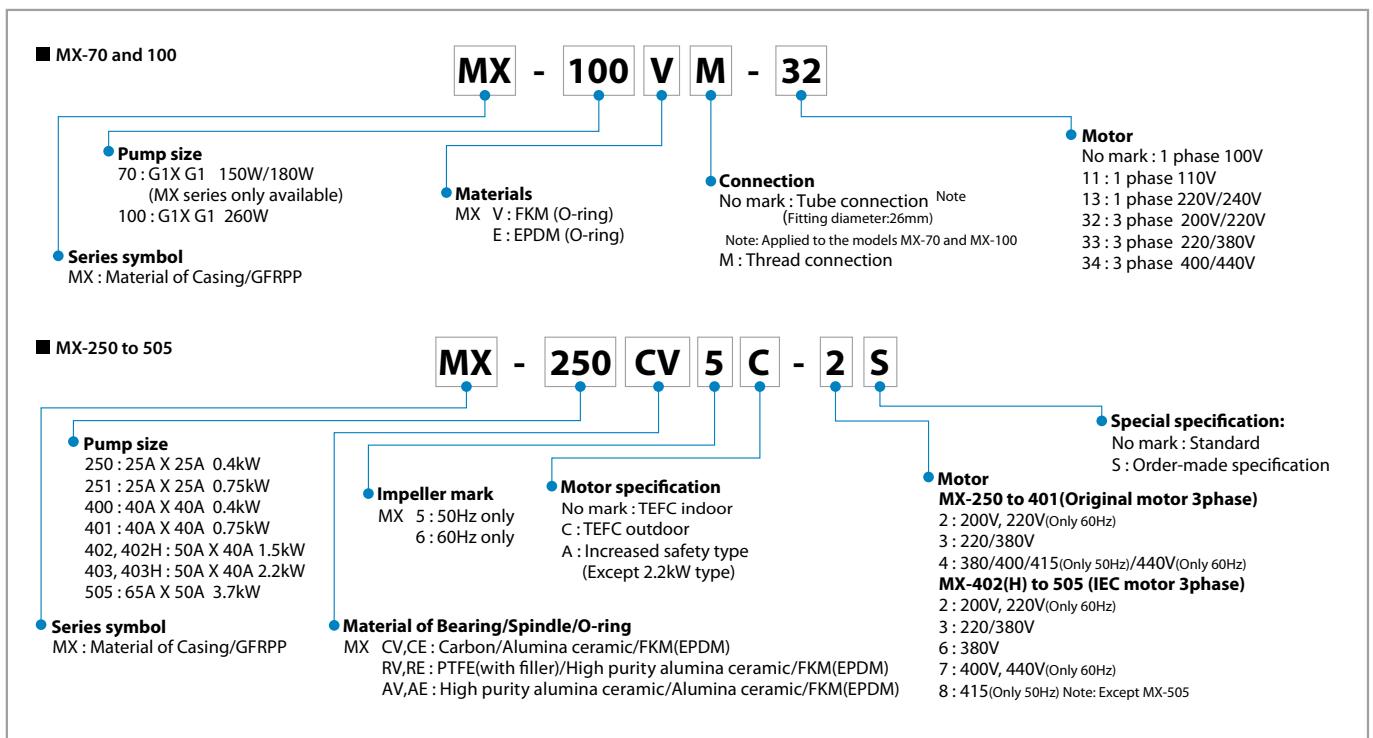

Specifications

50/60Hz

Model	Connection Suction X Discharge	Limit of specific gravity	Standard capacity L/min - m	Maximum capacity L/min	Motor kW	Mass kg
MX-70M	G1 x G1	1.2	50 - 5.4 / 7.8	90 / 100	0.15 / 0.18	6.5
MX-100M	G1 x G1	1.2	70 - 6 / 9	110 / 125	0.26	8.2
MX-250	25A x 25A	1.0	50 - 14 / 13.5	150	0.4	13.5
MX-251	25A x 25A	1.0	80 - 19	150	0.75	18.5
MX-400	40A x 40A	1.2	100 - 10.5 / 10	280	0.4	13.5
MX-401	40A x 40A	1.2	150 - 14.5	320	0.75	18.5
MX-402	50A x 40A	1.2	200 - 20/19.5	450	1.5	30.5
MX-402H	50A x 40A	1.0	100 - 30	160	1.5	30.5
MX-403	50A x 40A	1.2	250 - 23 / 25	500	2.2	33
MX-403H	50A x 40A	1.0	100 - 35 / 36	300 / 250	2.2	33
MX-505	65A x 50A	1.2	500 - 24.5 / 23.5	800	3.7	53.5

Note 1) The specific gravity limit values shown above are with maximum discharges. The specific gravity limit varies with the discharge. For details, please contact us.

Note 2) 26mm tube connection option available on the MX-70 and MX-100.

Note 3) AV(AE) type is different in discharge capacity. For details, please contact us.

Common specifications

• Range of liquid temperature : 0 to 80°C (10 to 80°C in case AFLAS® O-rings are used.) • Range of ambient temperature : 0 to 40°C.

Performance curves

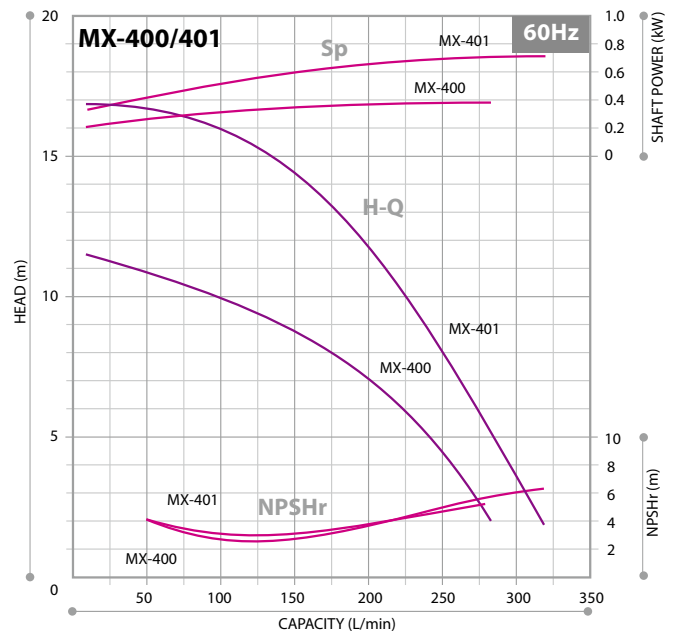
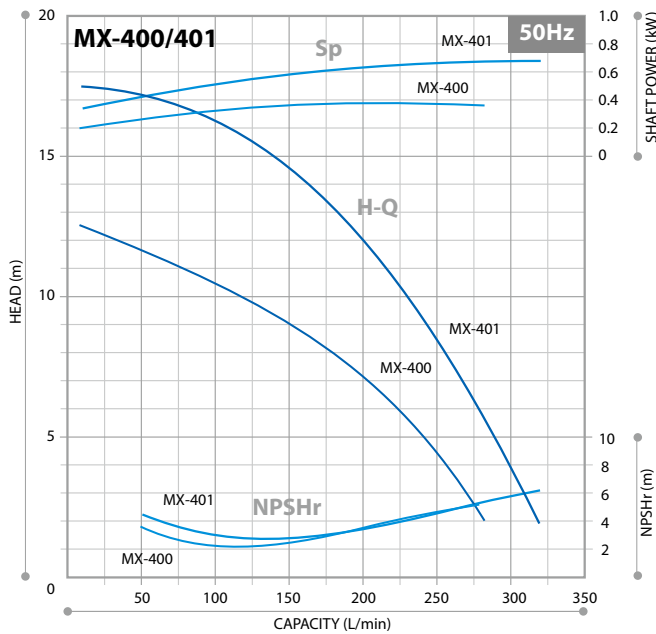
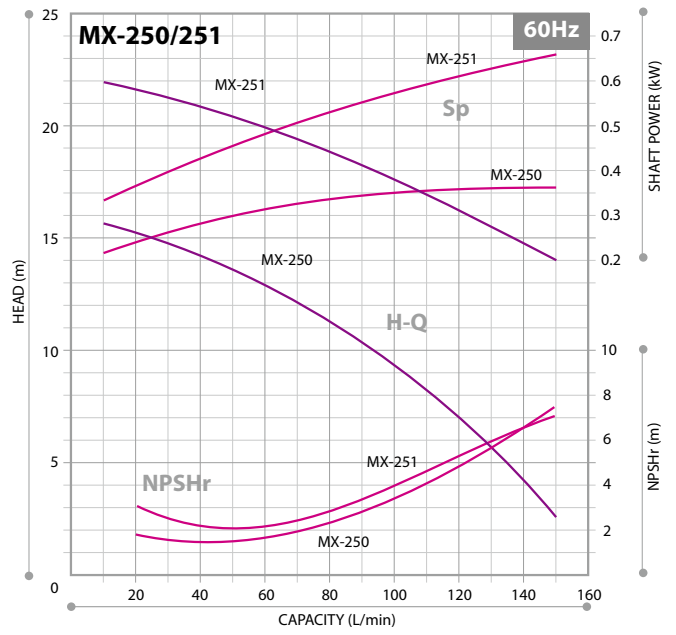
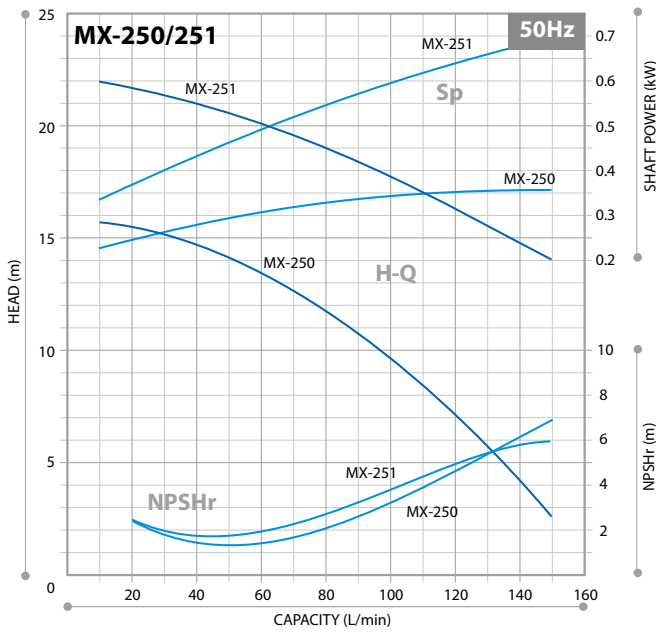
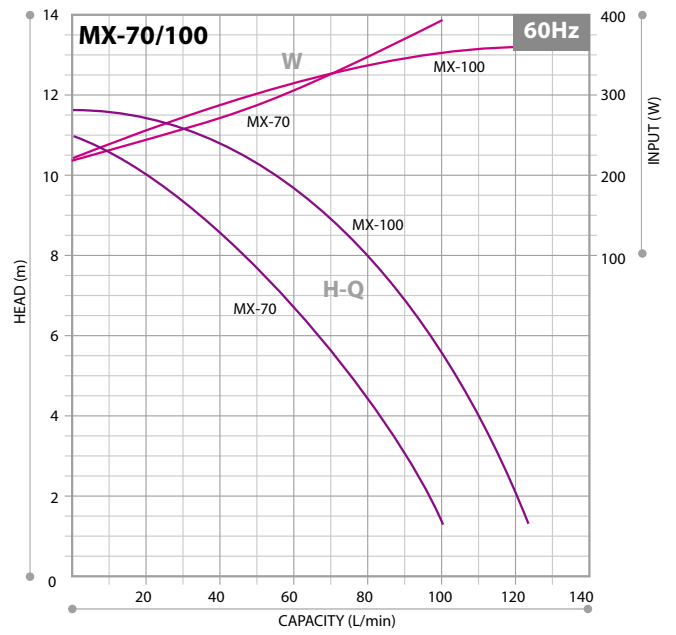
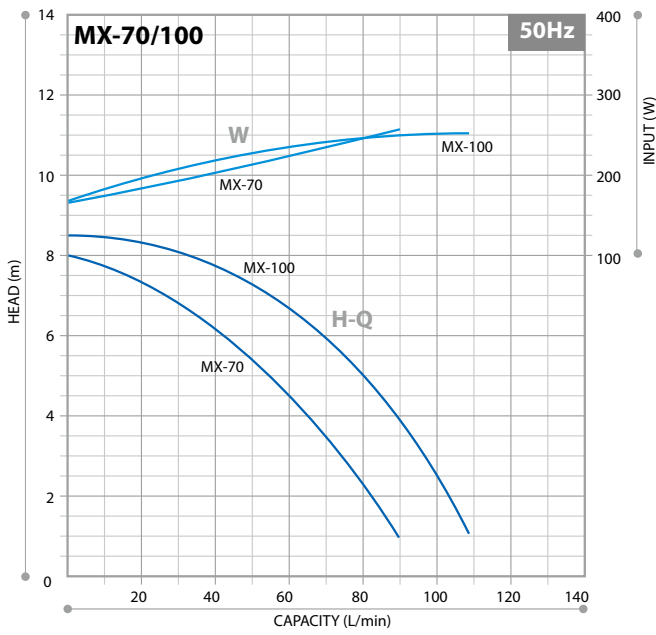

Performance curves

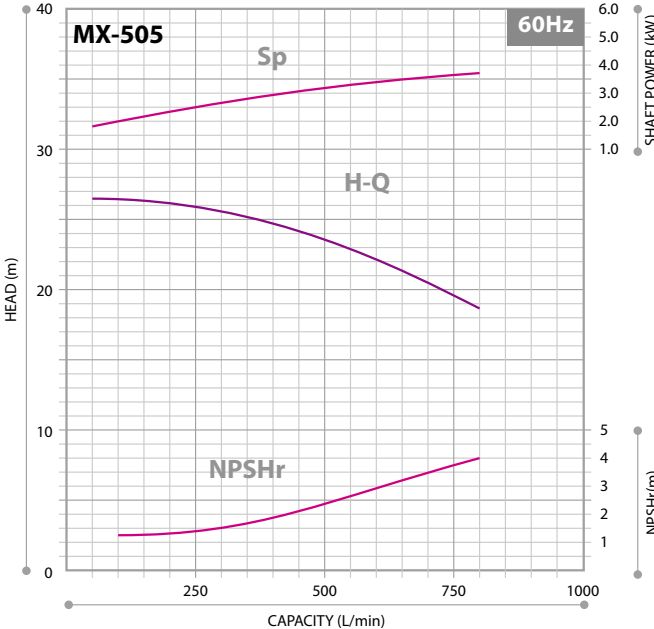
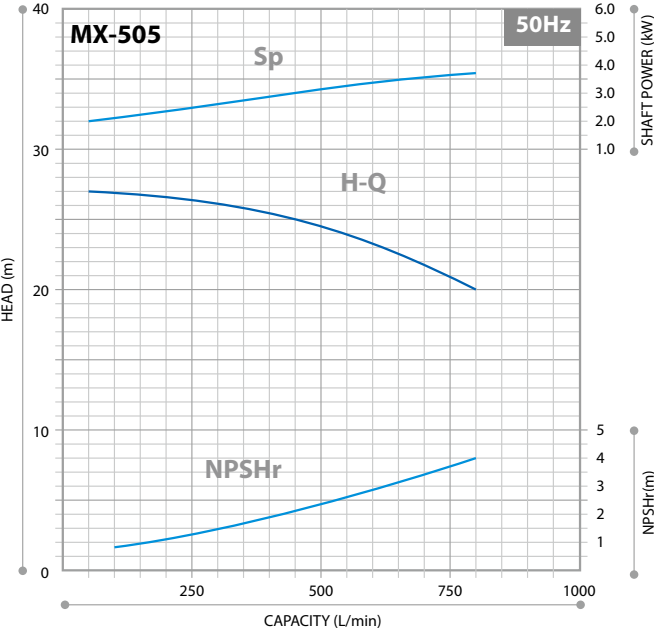
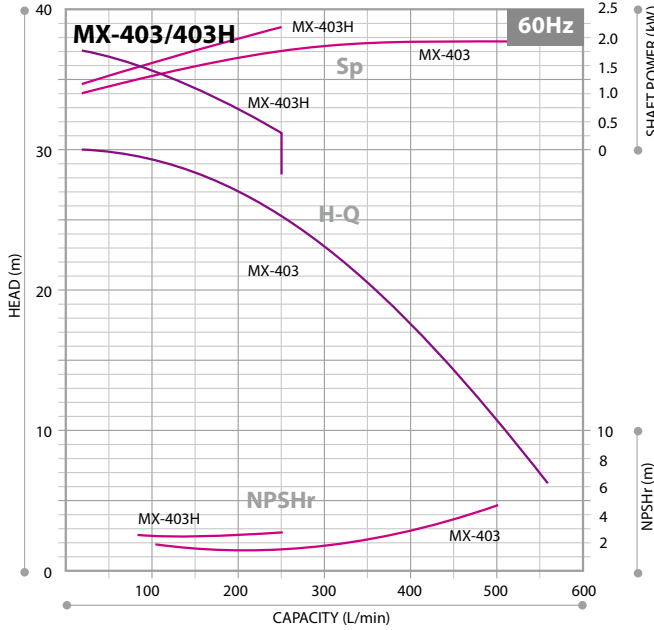
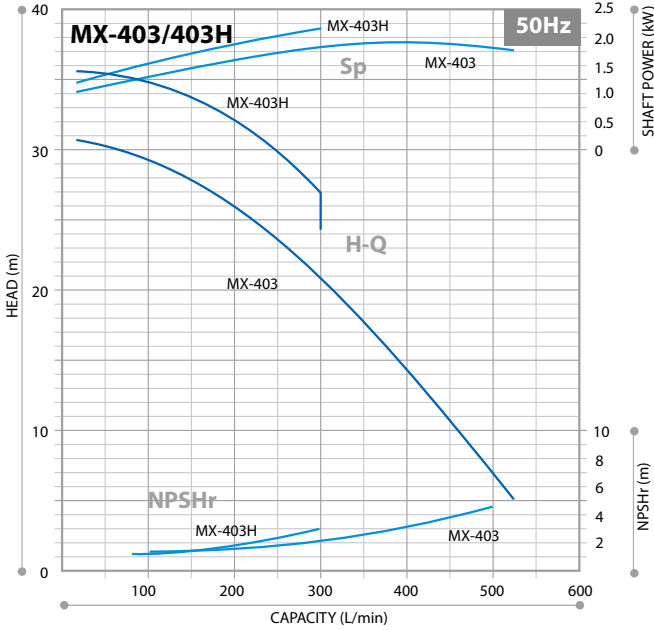
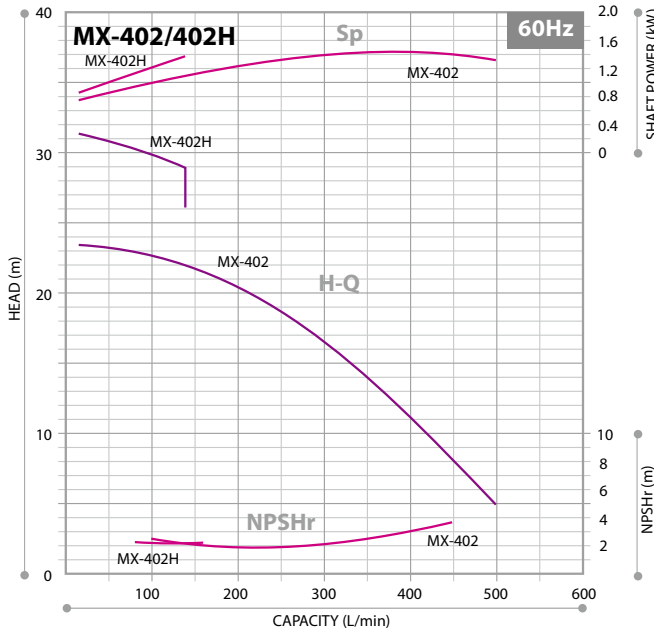
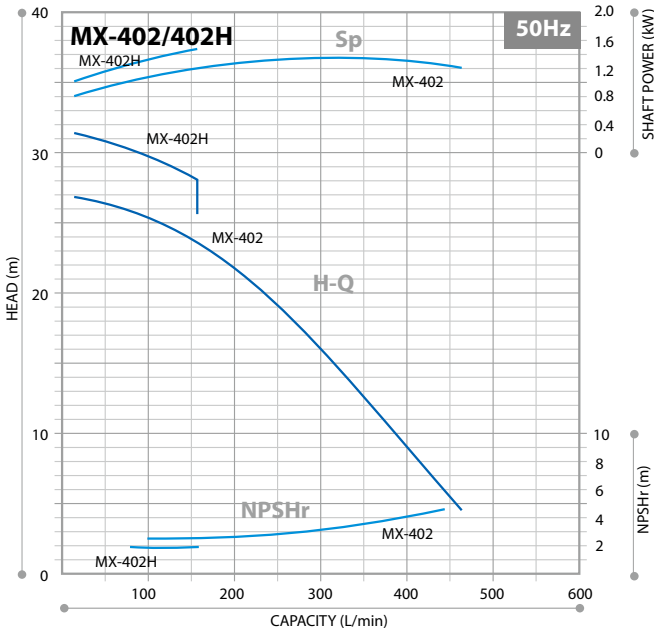

Dimensions

MX-70, 100

Note

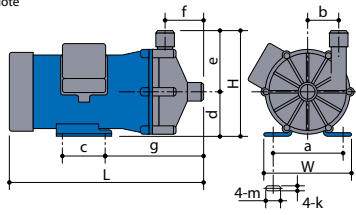

MX-250 to 401

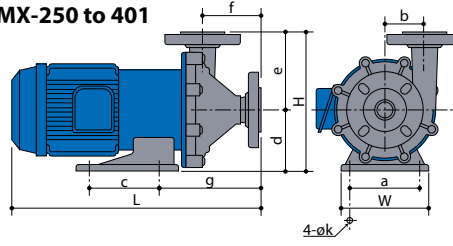

MX-402, 402H, 403, 403H

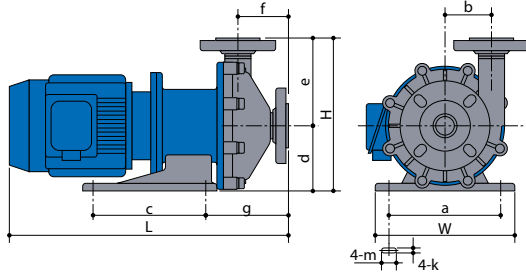

MX-505

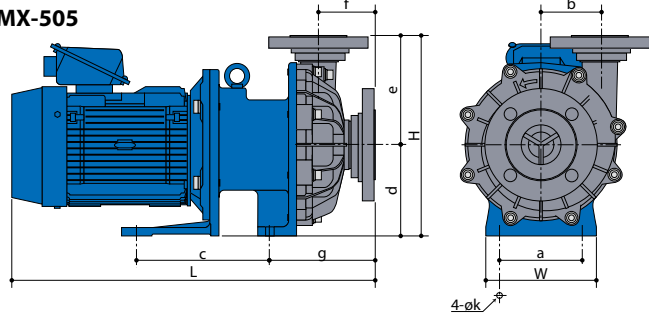

Models	W	H	L	a	b	c	d	e	f	g	k	m
MX-70	130	155	258.5	110	48	40	65	90	53	159.5	7	11
MX-100	150	175	319.5	110	51	70	75	100	65	162	9	27
MX-250	160	255	411	130	65	130	115	140	90	163	12	—
MX-251	160	255	444	130	65	130	115	140	90	171	12	—
MX-400	140	225	411	110	54	98	95	130	87	150	12	—
MX-401	160	255	457	130	72	130	115	140	103	184	12	—
MX-402, 402H, 403, 403H	260	280	516	208	80	200	120	160	89	157	14	36
MX-505	180	330	601	140	96	220	150	180	95	175	14	—

Note 1: MX-70 and MX-100 shows thread type in the above dimensions, Please contact us for tube connection type.

Optional accessories

Iwaki dry running protector DR series

Model DR is electric current sensing type dry running protector. It detects the decreased load current (lower limit) to stop the pump when it runs dry or runs with air sucking in. It can detect over-load, too.

- Current figure to be set is indicated on LCD.
- Both top/bottom figures can be set.
Top:Over-load
Bottom:Dry running, air sucking-in operation, operation with suction side closed
- Built-in current transformer
- DIN rail mounting
- It is unable to use DR when inverter is employed in the system.

Specification

50/60Hz

Model	DR-10	DR-20
Motor power	200 to 240V three phase	380 to 440V three phase
Applied motor	0.4 to 7.5kW	0.75 to 15kW
Power control	100 to 240V single phase	
Power	100V ±10%single phase	
Input	200 to 240V ±10%single phase	
Detective current	3.5W	
Current transformer(CT)	0.5 to 32.0A	
Outer dimension	Built-in	
	D80 X W153 X H122	



DR-20

Union joint (Option)
Special purpose union joints are available.
Material : PVC/Heat resistant PVC



IWAKI CO., LTD. 6-6 Kanda-Sudacho 2-chome Chiyoda-ku Tokyo 101-8558 Japan
TEL : (81)3 3254 2935 FAX : 3 3252 8892

()Country codes

IWAKI has global net work. Please find your distributor location at

www.iwakupumps.jp

European office : IWAKI Europe GmbH
Germany : IWAKI Europe GmbH
Holland : IWAKI Europe GmbH (Netherlands Branch)
Italy : IWAKI Europe GmbH (Italy Branch)
Spain : IWAKI Europe GmbH (Spain Branch)
Belgium : IWAKI Belgium N.V.
Denmark : IWAKI Nordic A/S
Finland : IWAKI Suomi Oy
France : IWAKI France S.A.
Norway : IWAKI Norge AS
Sweden : IWAKI Sverige AB
U.K. : IWAKI Pumps (UK) Ltd.

TEL: (49)2154 9254 0 FAX: 2154 9254 48
TEL: (49)2154 9254 50 FAX: 2154 9254 55
TEL: (31)74 2420011 FAX: (49)2154 925448
TEL: (39)0444 371115 FAX: 0444 335350
TEL: (34)93 37 70 198 FAX: 93 47 40 991
TEL: (32)13 67 02 00 FAX: 13 67 20 30
TEL: (45)48 24 2345 FAX: 48 24 2346
TEL: (358)9 2745810 FAX: 9 2742715
TEL: (33)1 69 63 33 70 FAX: 1 64 49 92 73
TEL: (47)23 38 49 00 FAX: 23 38 49 01
TEL: (46)8 511 72900 FAX: 8 511 72922
TEL: (44)1743 231363 FAX: 1743 366507

U.S.A. : IWAKI America Inc.
Argentina : IWAKI America Inc. (Argentina Branch)
Singapore : IWAKI Singapore Pte Ltd.
Indonesia : IWAKI Singapore (Indonesia Branch)
Malaysia : IWAKI M Sdn. Bhd.
Australia : IWAKI Pumps Australia Pty Ltd.
Hong Kong : IWAKI Pumps Co., Ltd.
China : GFTZ IWAKI Engineering & Trading Co., Ltd.
: IWAKI Pumps (Shanghai) Co., Ltd.
Korea : IWAKI Korea Co.,Ltd.
Taiwan : IWAKI Pumps Taiwan Co., Ltd.
Thailand : IWAKI (Thailand) Co.,Ltd.
Vietnam : IWAKI Pumps Vietnam Co., Ltd.

TEL: (1)508 429 1440 FAX: 508 429 1386
TEL: (54)11 4745 4116
TEL: (65)6316 2028 FAX: 6316 3221
TEL: (62)21 6906606 FAX: 21 6906612
TEL: (60)3 7803 8807 FAX: 3 7803 4800
TEL: (61)2 9899 2411 FAX: 2 9899 2421
TEL: (852)2607 1168 FAX: 2607 1000
TEL: (86)20 84350603 FAX: 20 84359181
TEL: (86)21 6272 7502 FAX: 21 6272 6929
TEL: (82)2 2630 4800 FAX: 2 2630 4801
TEL: (886)2 8227 6900 FAX: 2 8227 6818
TEL: (66)2 322 2471 FAX: 2 322 2477
TEL: (84)613 933456 FAX: 613 933399

Caution for safety use:
Before use of pump, read instruction manual carefully to use the product correctly.

Legal attention related to export.

Our products and/or parts of products fall in the category of goods contained in control list of international regime for export control. Please be reminded that export license could be required when products are exported due to export control regulations of countries.

Actual pumps may differ from the photos. Specifications and dimensions are subject to change without prior notice. For further details please contact us.

